

EOFY 2024 SPECIALS

ON SALE UNTIL JUNE 30TH 2024

MATERIALS HANDLING, WORKPLACE & SAFETY EQUIPMENT



See Page 29

See Page 16

See Page 20

See Page 30

See Page 10

See Page 28

See Page 25

See Page 18

SCAN TO VIEW THE BIGGEST RANGE IN AUSTRALIA



FREE GIVEAWAYS

SEE PAGE 2

SCAN TO VIEW GIVEAWAYS ONLINE

ABN: 38 368 064 476

Brisbane (07) 3558 9700

42 Mineral Sizer Court, Narangba QLD 4509
sales@mhaproducts.com.au

Sydney (02) 8865 1800

1 Fairview Place, Marsden Park NSW 2765
sales@mhaproducts.com.au

Melbourne (03) 9115 9100

52 Gilbert Park Drive, Knoxfield VIC 3180
sales@mhaproducts.com.au



DELIVERING AUSTRALIA WIDE DAILY!

Contact us
for a copy of our
full catalogue

or download a copy here:



www.mhaproducts.com.au/catalogue

**FREE PACK OF
ULTRAGRIME WIPES**



FOR ALL ORDERS OVER \$100

Scan to view our
full range online



**FREE
WITH ORDERS
OVER \$400**



**FREE
WITH ORDERS
OVER \$1000**



**FREE
WITH ORDERS
OVER \$5000**



**FREE
WITH ORDERS
OVER \$6000**

View details online at www.mhaproducts.com.au/giveaways

V-Cart Folding Plastic & Aluminium Trolley

- The V-Cart is supplied with one collapsible basket which will lock into place on either the top or bottom platform
- The top platform can be folded back to allow larger items to be transported if required
- Extra baskets are available for use on both platforms
- A robust foot pedal brake allows the V-Cart to be locked in position whilst loading or unloading
- The V-Cart can also be used with our standard No.7, No.10 & No.15 tubs
- Overall Length Assembled: 1000mm
- Overall Width Assembled: 600mm
- Overall Height Assembled: 1070mm
- Overall Length Folded: 740mm
- Overall Width Folded: 540mm
- Overall Height Folded: 105mm
- Total Trolley Capacity: 90kg
- Top Shelf Capacity: 40kg
- Bottom Shelf Capacity: 50kg
- Trolley Weight: 10kg
- Basket Weight: 1.8kg
- Basket Capacity: 25kg
- Handle Height: 1050mm
- Rear Wheel Diameter: 180mm
- Front Wheel Diameter: 85mm
- Basket Dimensions (External):
V-Cart Basket Code: M1805
Overall Length: 560mm
Overall Width: 400mm
Overall Height: 260mm
- Basket Dimensions (Internal):
Overall Length: 525mm
Overall Width: 365mm
Overall Height: 255mm



Code	Details	WAS	NOW
M1800	V-Cart Folding plastic & Aluminium Trolley (includes 1 folding basket)	\$395	\$245
M1805	V-Cart Extra Basket	\$55	\$39
M1815	V-Cart Tool Bin (supplied with 2 removable dividers)	\$48	\$36
M1810	V-Cart Vinyl Cover	\$135	\$95

Packaging/Carton Trolley

- Bolt together construction
- Zinc plated finish
- Load Capacity: 350kg
- Rubber Castors: 2 x swivel & 2 x swivel with brakes
- Castors: 125mm
- Handle Height: 1065mm
- Base Height: 223mm
- Overall Size (LxWxH): 1472x680x1710mm
- Distance between level/shelves 947mm
- Adjustable top shelf at 200mm increment
- Distance between dividers: 430mm
- Adjustable Divider at 40mm increment along the shelf
- Unit Weight: 49kg



Code	WAS	NOW
M1941	\$1,241	\$998



Powered Platform Trolley (with cage)

- These powered heavy duty platform trolleys provide a strong 400kg capacity platform to move heavy items around your workplace
- The removable cage is designed to avoid items from falling out
- Platform has an anti-slip grip so that items don't slide off easily in transit
- Emergency stop button
- Forward & reverse drive options
- Variable speed controller
- Powered by 2 x 12V / 33Ah batteries
- Pneumatic drive wheels with swivel rear castors
- Cage Height: 930mm
- Moving Speed: 5-8km/h
- Load Capacity: 400kg
- Overall Size:(LxWxH) 1420x630x1090mm
- Unit Weight: 110kg



Code	WAS	NOW
MI065	\$3,110	\$2,799

Large Powered Platform Trolley

- Platform has an anti-slip grip so that items don't slide off easily in transit
- Supplied standard with removable cage
- Rubber bumper edge
- Emergency stop button
- Comes with forward/reverse drive options
- Variable speed controller
- Powered by 3 x 12V / 55Ah batteries
- Battery lasts for 6 hours, continuous operation
- Wheel Size: 310mm (pneumatic)
- Clearance From Battery Box to Ground: 75mm
- Moving Speed: 3-6km/h
- Load Capacity: 800kgs
- Handle Height: 950mm
- Overall Size (LxWxH):2070x900x980mm
- Platform Size: 1400x900mm
- Platform Height: 385mm
- Unit Weight: 170kg



Code	WAS	NOW
MI066	\$5,995	\$5,395

Powered Dump Truck Trolley

- Great for dirt, bark & rubbish removal in outdoor areas
- Emergency stop button
- Comes with forward & reverse drive options
- Variable speed controller
- Powered by 3 x 12V / 55Ah batteries
- Load Capacity: 800kgs
- Wheel Size: 325mm (pneumatic)
- Moving Speed: 5-8km/h
- Lift Time: 15 secs
- Lift Angle: 45 degrees
- Tray Size (LxWxH): 1510x800x310mm
- Overall Size (LxWxH): 2250x810x1070mm
- Unit Weight: 250kg



Watch a video of this in operation on our website here: www.mhaproducts.com.au/MI067



Code	WAS	NOW
MI067	\$7,420	\$6,678



Pipe Trolley

- Designed to safely store & transport long length materials such as pipe & conduit on site. These mobile storage solutions increase worker productivity by keeping materials organised & close to work areas
- Heavy duty construction for maximum stability
- Suitable to store & transport long materials such as pipe, conduit, tubing & bar stock
- 8 spaces available for sorting & accessing pipes
- Arm stops prevent items falling off
- Optional 4 corner posts supplied for fitting to base frame
- Industrial 150mm poly/cast wheels with brakes allow easy maneuvering around the worksite
- Overall Dimensions (LxWxH): 1895x1065x1790mm
- Working Load Limit: 2000kg
- Zinc finish
- Unit Weight: 112kg



Code	WAS	NOW
M1280	\$1,160	\$1,032

A-Frame Trolley for Glass

- Suitable for storing & transporting glass, stone & other sheet materials
- Load is secured by 4 adjustable clamp bars
- Detachable ratchet straps supplied
- Rubber profiles protect the load from damage & help prevent movement
- 4-way fork access & crane lugs fitted for transport by forklift or crane
- 150mm poly wheels with brakes
- Base is designed with racking locators to suit storage in highbay racking
- Maximum Load Width: 340mm
- Fork Pocket Size: 250x80mm
- Overall Size (LxWxH): 1800x1150x1620mm
- Zinc finish
- Unit Weight: 130kg



Code	WAS	NOW
M1281	\$1,980	\$1,780

Transport Trolley (with Storage Basket)

- Steel tubular frame & heavy duty plywood base with a storage basket
- Pneumatic wheels for transporting large & bulky items on rough ground
- 2 x 200mm swivel rubber castors with brake
- 2 x pneumatic fixed centre wheels
- Load Capacity: 500kg
- Pneumatic castors: 260mm
- Platform Height: 320mm
- Overall Size: (LxWxH) 1000x700x1250mm
- Unit Weight: 36kg



Code	WAS	NOW
M1248	\$615	\$525



3 Tier Utility Cart

- Versatile functional carts for food service, catering etc
- Lightweight, strong, reinforced polymer construction with aluminium posts
- Spacing Between Shelves: 340mm
- Load Capacity: 150kg
- 75mm rubber castors
- Handle Height: 910mm
- Shelf Size: 600x430mm
- Overall Dimensions (LxWxH): 845x430x910mm
- Unit Weight: 10kg



Code	WAS	NOW
M1450	\$228	\$205

Extra Long 3 Tier Service Trolley

- These utility carts have polypropylene side panels which keep the load more secure on the trolley
- Rubber castors: 2 x swivel & 2 x swivel with brakes
- Load Capacity: 250kg
- Castors: 100mm
- Tray Size: 920x520mm
- Overall Size (LxWxH): 1110x520x1010mm
- Unit Weight: 21kg



Code	WAS	NOW
M1456	\$495	\$445

3 Tier Service Cart

- Heavy duty plastic construction is dent, chip & rust resistant
- 4 x 100mm swivel castors (2 locking castors)
- Lockable front doors
- Load Capacity: 250kg
- Top Shelf Capacity: 125kg
- Shelf Size: 680x450mm
- Handle Height: 1000mm
- Top tray height: 880mm
- Top tray size (LxDxH): 680x450x65mm
- Internal cabinet size: (LxDxH) 670x435x275mm
- Overall Size (LxWxH): 870x500x1010mm
- Unit Weight: 17kg



Code	WAS	NOW
M1461	\$425	\$382

Quad Deck Tool Cart

- Excellent tool cart with square hole pegboard
- Supplied with accessories
- Tray depth: 50mm
- Rubber castors: 2 x swivel & 2 x swivel with brakes
- Load Capacity: 300kg
- Castors: 100mm
- Shelf Heights: 170+370+570 +770mm
- Shelf Size: 585x405mm
- Overall Size: 680x430x1215mm
- Unit Weight: 24kg



Code	WAS	NOW
M1466	\$695	\$599

Extra Large Prestige Platform Trolley

- Heavy duty castors
- Powder coated steel frame & handle with vinyl decks
- Surround bumper on perimeter of trolley
- Rear wheels are fixed castors & front wheels are swivel castors
- Load Capacity: 650kg
- Castor Size: 200mm
- Handle Height: 1035mm
- Overall Size (LxWxH): 1180x765x1035mm
- Platform Size: 1125x720mm
- Platform Height: 245mm
- Unit Weight: 40kg



Code	WAS	NOW
M1015	\$759	\$683

Heavy Duty Sloping 4 Shelf Trolley

- Heavy duty bolt together trolley which is great for stock picking
- 4 sloping backwards shelves which prevents items falling off the shelves
- Shelves are removable
- Distance between shelves: 350mm
- Shelf Size: 1460x730mm
- 150mm Rubber Castors: 2 x fixed & 2 swivel with brakes
- Load Capacity: 500kg
- Overall Size (WxDxH): 1730x770x1770mm
- Unit Weight: 122kg



Code	WAS	NOW
M1081	\$1,497	\$1,128



Platform Cage Trolley

- Industrial quality cage trolley with fold down sides for easy loading/unloading
- Powder coated steel construction with vinyl platform
- Surround bumper on perimeter of trolley
- Load Capacity: 370kg
- Platform Size: 880x580mm
- Platform Height: 190mm
- Overall Size: (LxWxH) 1000x620x1000mm
- 125mm Polyurethane Castors: 2 x fixed & 2 x swivel
- Unit Weight: 27kg



Code	WAS	NOW
M1031	\$489	\$439

Extra Large Platform Trolley (with cage)

- Powder coated steel construction with vinyl decks & surround bumper
- Load Capacity: 500kg
- Castors: 200mm
- Rear wheels are fixed castors & front wheels are swivel castors
- Overall Size: 1270x770x1000mm (LxWxH)
- Platform Size: 1170x770mm
- Handle Height: 1000mm
- Platform Height: 240mm
- Cage Height: 770mm
- Unit Weight: 47kg



Code	WAS	NOW
M1032	\$856	\$770

Aluminium Hand Trolley

- Great lightweight hand truck for general load carting
- Flat free tyres
- Load Capacity: 150kg
- Castors: 260mm
- Foot Plate Size (WxD): 355x180mm
- Overall Size (WxDxH): 520x470x1260mm
- Unit Weight: 10kg



Code	WAS	NOW
M1190	\$269	\$242

Chair Trolley

- Lifts & moves stacks of chairs with ease!
- Tyre Type: Rubber
- Capacity: 10 Chairs
- Finish: Powdercoated - Black
- Rubber Castors: 2 x fixed & 2 x swivel
- Load Capacity: 150kg
- Front Castors: 200mm
- Rear Castors: 100mm
- Handle Height: 1120mm
- Overall Size (LxWxD): 1080x490x1350mm
- Unit Weight: 15kg



Code	WAS	NOW
M1208	\$552	\$495

Heavy Duty Appliance Trolleys

- Industrial quality hand trolleys to suit a variety of applications
- Powdercoated steel frame with poly load protectors
- M1250 + M1255 are supplied with appliance strap
- Load Capacity: M1250/M1255: 350kg | M1257: 300kg
- Foot Size: M1250/M1255: 450x200mm | M1257: 350x240mm
- Overall Size: M1250/M1255: 610x1520mm | M1257: 525x1305mm
- Unit Weight: M1250: 22kg | M1255: 19kg | M1257: 15kgw

Code	Details	WAS	NOW
M1250	Stair Climber Appliance Trolley	\$420	\$372
M1255	Flat Free Appliance Trolley	\$365	\$318
M1257	P Handle Trolley with extended foot	\$245	\$213



Heavy Duty Mesh Cage Trolley

- The featured doors & roof help protect items being stored & transported
- Comes with signboard area on the side
- Supplied with a removable front bar, allowing the doors to open & the sides to fold up
- Rubber castors: 2 x swivel & 2 x swivel with brakes
- Overall Size (LxWxH): 1100x850x1700mm
- Powder coated finish
- Base Height: 200mm
- Shelf Capacity: 125kg
- Load Capacity: 500kg
- Castors: 125mm
- Shelf Size: 1020x750mm
- Unit Weight: 71kg



Optional heavy duty removable shelves available

Code	Details	WAS	NOW
M1905	Heavy Duty Mesh Cage Trolley	\$1,357	\$1,194
M1901	Extra Shelf to suit Mesh Cage Trolley	\$165	\$152

4 Sided Roll Cage Trolley

- Back of Trolley has 2 half doors for easy access to product inside
- Front of Trolley has 1 full length door
- Middle shelf is fold-able
- Load Capacity: 500kg
- 125mm Castors: 2 x fixed & 2 x swivel
- Overall Dimensions (WxDxH): 845x760x1855mm
- Internal Dimensions (WxDxH): 770x695x1635mm
- Lower Shelf Height: 210mm
- Upper Shelf Height: 1140mm
- Mesh Size: 110x90mm
- Shelf Size: 770x695mm
- Finish: Zinc
- Unit Weight: 56kg



Trolleys are nestable to increase space efficiency

Code	WAS	NOW
M1763	\$695	\$610

Retail Stock Trolley

- Features large spacious shelves, making it suitable for transferring goods of any type throughout super markets, factories & large warehouses
- Load Capacity: 400kg
- Electro galvanised & clear coated
- Rubber castors: 2 x fixed & 4 x swivel
- Castors: 125mm
- Height to top shelf: 715mm
- Distance Between Shelves: 475mm
- Overall Size (LxWxH): 1320x430x1120mm
- Unit Weight: 24kg



Code	WAS	NOW
M1685	\$607	\$546

Mesh Trolley with Folding Lid

- Perfect solution for hospitals, laundries & nursing homes etc
- Lockable lid ensures goods are stored securely
- Load Capacity: 100kg
- White powder coated finish
- Polyurethane castors: 4 x swivel
- Castors: 100mm
- Size of basket (LxWxH): 770x570x430mm
- Overall Size (LxWxH): 800x600x915mm
- Unit Weight: 18kg



Code	WAS	NOW
M1680	\$415	\$382



2 Tier Trolley with Bottom Basket

- Simple bolt together construction
- Load Capacity: 300kg
- Overall Dimensions (LxWxH): 1095x660x1221mm (includes handle)
- Handle Height: 1050mm
- 125mm rubber castors: 2 x fixed & 2 x swivel with brakes
- Optional 200mm pneumatic wheel kit available with floor brake
- Overall Shelf Size: 960x655mm
- Internal Tray Size: 905x600
- Base Height: 184mm
- Upper Shelf Height: 1221mm
- Basket Size (LxWxH): 905x600x375mm
- Distance between shelves: 337.50mm
- Reversible top shelf which gives a tray option
- Unit Weight: 51.3kg
- For optional accessories see pg. 10



M1896 can fit up to 4 x M7833 plastic tubs

Reversible top shelf which gives a tray option

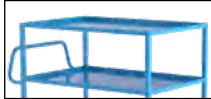

Tubs are sold separately*

Code	WAS	NOW
M1896	\$1,155	\$1,035

4 & 5 Tier Steel Trolleys

- Simple bolt together construction
- Load Capacity: 300kg
- Handle Height: 1050mm
- 125mm rubber castors: 2 x fixed & 2 x swivel with brakes
- Optional 200mm pneumatic wheel kit available with floor brake
- Overall Shelf Size: 960x655mm
- Internal Tray Size: 905x600
- Base Height: 184mm
- M1894: Overall Dimensions (LxWxH): 1095x660x1221mm Upper Shelf Height: 1221mm Distance between shelves: 313, 303 & 337.50mm Unit Weight: 51.5kg
- M1895: Overall Dimensions (LxWxH): 1095x660x1573mm Upper Shelf Height: 1573mm Distance between shelves: 313, 327, 312, 327mm Unit Weight: 62kg
- For optional accessories see pg.10



M1894



M1895

Reversible top shelf which gives a tray option

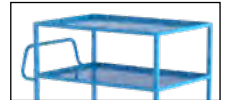

Code	Details	WAS	NOW
M1894	4 Tier Steel Trolley	\$1,045	\$939
M1895	5 Tier Steel Trolley	\$1,187	\$1,063

Full Cage Trolley with Double Swing Door

- Lockable double swing door (180 degree opening)
- 125mm Rubber Castors: 2 x fixed & 2 x swivel with brakes
- Optional 200mm pneumatic wheel kit available with floor brake
- Load Capacity: 300kg
- Overall Dimensions (LxWxH): 1095x660x1573mm (includes handle)
- Internal Dimensions (LxWxH): 910x605x1355mm
- Handle Height: 1050mm
- Base Height: 184mm
- Mesh Size: 50x50mm
- Unit Weight: 73.8kg
- For optional accessories see pg. 10



M1897 can fit up to 8 x M7833 plastic tubs

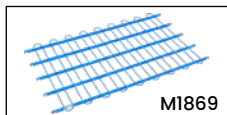

M1869



Tubs & Mesh Shelves are sold separately*

Code	Details	WAS	NOW
M1897	Full Cage Trolley with Double Swing Door	\$1,445	\$1,292
M1869	Mesh Shelf to suit Full Cage Trolley	\$98	\$87

Mesh Cage Trolley with 2 Tiers

- Can be used for a variety of storage & transportation purposes across a range of industries
- 125mm rubber castors: 2 x fixed & 2 x swivel with brakes
- Optional 200mm pneumatic wheel kit available with floor brake
- Load Capacity: 300kg
- Overall Dimensions (LxWxH): 1095x660x1211mm (Includes Handle)
- Cage Internal Dimensions (LxWxH): 910x605x670mm
- Handle Height: 1050mm
- Base Height: 184mm
- Mesh Size: 50x50mm
- Overall Shelf Size: 960x655mm
- Internal Tray Size: 905x600
- Upper Shelf Height: 1221mm
- Distance between shelves: 337.50mm
- Unit Weight: 63.kg
- For optional accessories see pg.10

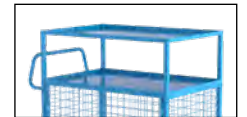

Reversible top shelf which gives a tray option

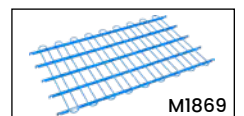

M1869

Tubs & Mesh Shelves are sold separately*

Code	Details	WAS	NOW
M1898	Mesh Cage Trolley with 2 Tiers	\$1,245	\$1,118
M1869	Mesh Shelf to suit Mesh Cage Trolley	\$98	\$87



Heavy Duty 3 Tier Platform Trolley

- Bolt together steel construction (supplied flatpack)
- Powder coated blue
- Rubber castors: 2 x fixed & 2 x swivel with brakes
- Castors: 160mm
- Load Capacity: 550kg
- Handle Height: 1000mm
- Shelf Size: 1100x600mm
- Overall Size (LxWxH): 1305x610x990mm
- Platform Size: 1100x600mm
- Shelf Heights:
3 tiers: 230+490+720mm
- 2 tiers: 230+720mm
- Unit Weight: 66kg
- Optional accessories available online



Middle shelf is removable to create a 2 tiered trolley



Code	Details	WAS	NOW
M1863	3 Tier Platform Trolley	\$1,138	\$908

2 & 3 Tier Steel Tub Trolleys

- Simple bolt together construction
- Suits 4 of the No. 4 or 4D size crates or 2 of the No. 7, 10 or 15 size crates in the top of the frame (middle bar has to be removed if using 7-15 size crates)
- Capacity: 300kg
- Overall Dimensions: (LxWxH) 1095x660x1050mm
- Handle Height: 1050mm
- Castors: 125mm
- Rubber Castors: 2 x fixed & 2 x swivel with brakes
- Base Height: 184mm
- Optional accessories available to suit on next page



M1882



M1883

Code	Details	WAS	NOW
M1882	2 Tier Steel Tub Trolley	\$665	\$593
M1883	3 Tier Steel Tub Trolley	\$775	\$697

*M1882 & M1883 aren't supplied with tubs however other sizes & colours can be purchased online. Search code M7833 on our website for tub options. M1882K & M1883K are kits which include the tubs.

2 Tier Steel Basket Trolleys

- Simple bolt together construction
- Mesh basket as top tray with 25mm punch holes
- Capacity: 300kg
- Overall Dimensions: (LxWxH) 1095x660x1050mm
- Handle Height: 1050mm
- Castors: 125mm
- Rubber Castors: 2 x fixed & 2 x swivel with brakes
- Shelf Height: 184mm (lower), 655mm (upper)
- Distance Between Baskets (M1886): 230mm
- Optional accessories available to suit on next page



M1885



M1886

Code	Details	WAS	NOW
M1885	2 Tier Steel Single Basket Trolley	\$779	\$705
M1886	2 Tier Steel Double Basket Trolley	\$885	\$803



Mesh Cage Steel Trolleys

- These trolleys prevent items falling in transit making them great for warehouses, factories & distribution centers
- Load Capacity: 300kg
- 125mm Rubber Castors: 2 x fixed & 2 x swivel with brakes
- Overall Dimensions (LxWxH): 1095x660x1050mm
- Base Height: 184mm
- Mesh Size: 50x50mm
- M1889/M1890 Door Opening Height: 550mm
- Optional accessories available to suit below



M1889



M1890



M1892

Code	Details	WAS	NOW
M1889	Mesh Cage Trolley with Drop Down Gate	\$795	\$716
M1890	Mesh Cage Trolley with Drop Down Gate & Lockable Lid	\$835	\$751
M1892	Mesh Cage Trolley with Lockable Double Swing Mesh Doors & Lid	\$835	\$751

M1892 Double Swing Door has a 180° opening & promotes accessibility for bulkier/heavier items in transit

2 Tier Rubber Top Trolley

- 2 Tier Rubber Top Trolley is ideal for warehouse tasks such as order picking
- Rubber top shelf prevents items from sliding off
- Load Capacity: 300kg
- Overall Dimensions (LxWxH): 1095x660x1050mm
- Handle Height: 1050mm
- Castors: 125mm
- Rubber Castors: 2 x fixed & 2 x swivel with brakes
- Shelf Size: 960x655mm
- Shelf Heights: 184mm (lower), 875mm (upper)
- Optional accessories available to suit below



M1887 Suits M7833 plastic tubs

Code	Details	WAS	NOW
M1887	2 Tier Rubber Tub Trolley	\$874	\$784

2 Tier Steel Deep Basket Trolley

- Mesh basket as top tray with 25mm punch holes
- Load Capacity: 300kg
- Overall Dimensions (LxWxH): 1095x660x1050mm
- Basket Size (LxWxH): 905x600x375mm
- Handle Height: 1050mm
- 125mm rubber castors: 2 x fixed & 2 x swivel with brake
- Base Height: 184mm
- Upper Level Height: 530mm
- Distance between Shelves: 313mm
- Optional accessories to suit below
- Additional accessories can be found online



Code	Details	WAS	NOW
M1893	2 Tier Deep Basket Trolley	\$796	\$733

Accessories to suit Steel Trolleys

Code	Details	WAS	NOW
M1841	Clipboard Holder Attachment	\$98	\$75
M1842	Laptop Holder Attachment	\$98	\$75
M1843	Mesh Basket Accessory Tray	\$85	\$53
M1844	Accessory Shelf Attachment	\$45	\$39
M1845	Pneumatic Wheel Kit	\$279	\$235
M1846	Floor Lock Brake	\$75	\$63
M1865	Ladder Kit	\$425	\$374
M1868	Optional Extra Handle	\$42	\$28



M1841
Clipboard Holder



M1842
Laptop Holder



M1843
Mesh Basket



M1844
Accessory Shelf



M1846
Floor Lock Brake

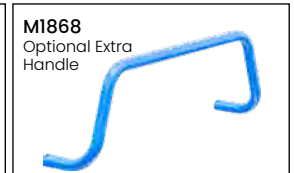

M1868
Optional Extra Handle

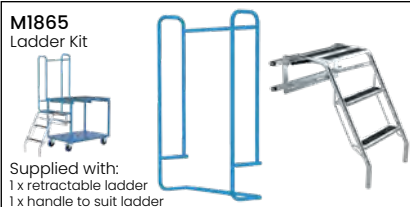

M1865
Ladder Kit

Supplied with:
1 x retractable ladder
1 x handle to suit ladder

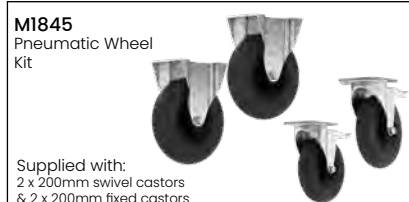

M1845
Pneumatic Wheel Kit

Supplied with:
2 x 200mm swivel castors
& 2 x 200mm fixed castors



Battery Electric Work Positioner

- Ideal for use in narrow aisles & confined spaces. Perfect for a range of applications such as pharmaceutical, catering, packing lines, food processing etc.
- Automatic electric overload protection system ensures safe operation
- Quick change attachment options available
- Battery electric with built in charger that you can plug in anywhere
- Load Capacity: 100kg
- Load Centre: 235mm
- Platform/ Attachment Size: 470x660mm
- Lifting Range: 130-1700mm
- Overall Size (LxWxH): 890x600x1990mm
- 24v, 7.2Ah battery
- Unit Weight: 62kg



Code	WAS	NOW
M2200	\$2,305	\$2,018

Manual Fork / Platform Stacker

- Foot pump hydraulic lift
- Comes with a removable platform and have 2 adjustable fork tines under platform for lifting skids & pallets
- Polyurethane castors: 2 x fixed & 2 x swivel with brakes
- Load Capacity: 400kg
- Rear Castors: 125mm
- Front Castors: 75mm
- Platform Size: 660x580mm
- Fork Length: 650mm
- Lifting Range: 75-1500mm
- Overall Size (LxWxH): 1040x590x1710mm
- Unit Weight: 85kg



Code	WAS	NOW
M2230	\$1,312	\$1,179

Electric Fork / Platform Stackers

- Electric hydraulic lift
- Battery: 12v 80Ah
- Comes with a removable platform & have 2 adjustable fork tines under platform for lifting skids & pallets
- Polyurethane castors: 2 x fixed & 2 x swivel with brakes
- Load Capacity: 400kg
- 125mm lockable rear castors
- 75mm front castors
- Platform Size: 660x580mm
- Fork Length: 650mm
- Lifting Range: 80-1500mm
- Overall Size (LxWxH): 1040x590x1710mm
- Unit Weight: 120kg



Code	WAS	NOW
M2231	\$3,447	\$3,115

120KG Fork / Platform Trolley

- Robust, light weight steel construction platform lift trolley which is ideal for lifting heavy items to a workbench level for working on
- The platform is removable & has 2 fork tines which are adjustable under platform for lifting small skids
- Load Capacity: 120kg
- Rear Castors: 200mm
- Front Castors: 50mm
- Platform Size: 500x420mm
- Fork Size: 50x420mm
- Lifting Range: 95-1050mm
- Overall Size (LxWxH): 700x460x1370mm
- Unit Weight: 39kg

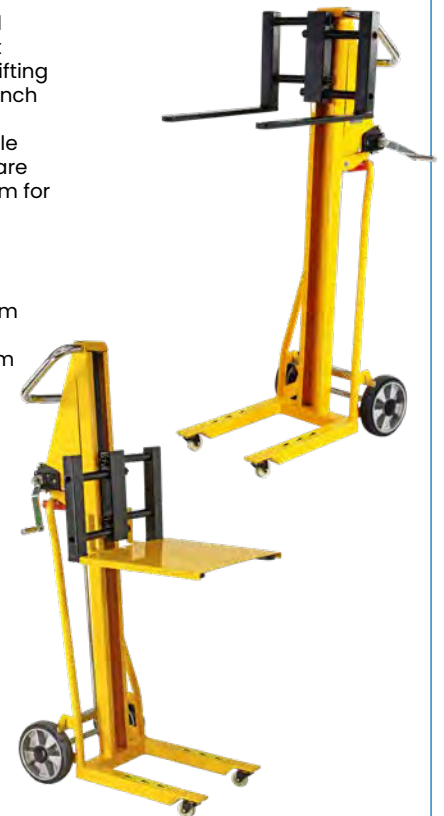

Code	WAS	NOW
M2255	\$1,090	\$947



Single Scissor Electric Lift Table

- High quality European power packs
- Self lubricating bushings on pivot points
- 240V power supply
- Upper platform lifted with aluminium safety bar
- Internal power pack equipped with relief valve against overloading and compensated flow valve for controlled lowering speed
- Heavy duty cylinders with drainage system & check valve to stop the lift table lowering in case of hose burst
- Push button pendant control with up, down & emergency stop
- Load Capacity: 2000kg
- Table Size: (WxL) 1000x2000mm
- Minimum Height: 250mm
- Maximum Height: 1300mm
- Raise Time: 25-30 seconds
- Unit Weight: 315kg



Code	WAS	NOW
M2151	\$5,695	\$5,126

Low Profile Electric Pallet Lift Table

- 85mm Clearance
- Hose burst safety valve
- Oil-less bushings on pivot points
- Load Capacity: 1000kg
- Platform Size: 1420x1140mm
- Lifting Range: 85-880mm
- Lift Time: 25 seconds
- Unit Weight: 357kg



24v control box



Watch a video of this in operation on our website here: www.mhaproducts.com.au/M2100



Code	WAS	NOW
M2100	\$4,890	\$4,035

Powdercoated Spring Pallet Elevator

- Can be moved with a standard pallet truck
- Keeps active layer of load at or above waist height, eliminating bending & lifting
- No ground fixing required
- Powder coated finish
- Load Capacity: 2000kg
- Fork Pocket Centres: 615mm
- Fork Pocket Size: 300x90mm
- Table Diameter: 1110mm
- Low Height: 290mm
- Max Height: 750mm
- Unit Weight: 195kg



Watch a video of this in operation on our website here: www.mhaproducts.com.au/M2134



Code	WAS	NOW
M2134	\$2,065	\$1,849

Powered Rotatable Electric Lift Table

- This electric pallet elevator has up/down pendant controls & an electric rotating top
- It is ideal for varying weight pallets with no need to change springs
- Powered rotation in both directions which can be set to rotate continuously
- Can be easily transported with a forklift
- No ground fixing required
- Power: 240V
- Load Capacity: 2000kg
- Lifting Range: 340-710mm
- Table Diameter: 1110mm
- Base Frame Size (LxW): 935x915mm
- Unit Weight: 190kg



Powered rotation with variable speed which can rotate continuously in both directions

Watch a video of this in operation on our website here: www.mhaproducts.com.au/M2126



Code	WAS	NOW
M2126	\$8,160	\$7,344



Manual & Electric Hi Lift Pallet Trucks

- Great for lifting skids & pallets with no bottom rail. Front support legs & adjustable stabilisers
- Overall Size: (LxW) 1150x680mm
- Quick-lift as standard with automatic transfer to normal lifting loads over 150kg
- Automatic descending speed control
- Lifting Range: 85-800mm
- Tine Size: 50x160mm
- **M2370:**
Load Capacity: 1000kg
Unit Weight: 125kg
- **M2372:**
Load Capacity: 1500kg
Unit Weight: 160kg
Electric: 12v, 54Ah



Code	WAS	NOW
M2370	\$1,374	\$1,237
M2372	\$3,405	\$3,098

Rough Terrain Pallet Truck

- Large pneumatic wheels
- Adjustable Fork Width: 228-735mm
- Width Inside Front Wheels: 1230mm
- Front Wheel Size: 550x132mm
- Rear Wheel Size: 265x80mm
- Turning Radius: 1500mm
- Axle Distance Between Front & Rear Wheels: 973mm
- Load Capacity: 1200kg
- Load Centre: 450mm
- Tine Size: 100x50mm
- Fork Length: 860mm
- Min Fork Height: 63mm
- Max Fork Height: 233mm
- Overall Size (LxWxH): 1375x1605x1200mm
- Unit Weight: 245kg



Code	WAS	NOW
M2360	\$1,935	\$1,795

Powdercoated Pallet Truck

- Safety yellow powdercoated truck provided with a maintenance free pump
- Fitted with long life rollers & steering wheel
- Load Capacity: 2500kg
- Fork Length: 1150mm
- Minimum Height: 85mm
- Overall Size: (WxL) 685x1550mm
- Tine Size: 50x160mm
- Steering Wheel Size: 50x180mm
- Polyurethane wheels
- Unit Weight: 70kg



Code	WAS	NOW
M2322	\$499	\$425

Stainless Steel Pallet Truck

- Ideal for food, chemical & pharmaceutical industries or where corrosive acids are used
- Grade of Stainless: 316
- Load Capacity: 2000kg
- Width: 520mm
- Minimum Height: 85mm
- Fork Length: 1150mm
- Tine Size: 60x160mm
- Steering Wheel Size: 50x200mm
- Nylon wheels
- Unit Weight: 75kg



Watch a video of this in operation on our website here:
www.mhaproducts.com.au/M2341



Code	WAS	NOW
M2341	\$3,995	\$3,595

The Edge - Electric Pallet Truck

- Load Capacity: 1500kgs
- Length of Tines: 1185mm
- **M2385** Overall Size (LxW): 1530x685mm
- **M2388** Overall Size (LxW): 1530x540mm
- Min Fork Height: 85mm
- Lowered Height: 80mm
- Lift Height: 115mm
- Raised Height: 195mm
- Wheel Type: Polyurethane
- Travel Speed (unloaded): 5.8 Km/h
- Turning Radius: 1330mm
- Electric Brake
- Brushless AC motor
- Emergency stop button



Battery: 24V 20Ah
(3-6 Hour Battery Life)



Watch a video of this in operation on our website here:
www.mhaproducts.com.au/M2385



Code	Details	WAS	NOW
M2385	The Edge - Electric Pallet Truck 1500kg - 685mm wide	\$3,895	\$3,499
M2388	The Edge - Electric Pallet Truck 1500kg - 540mm wide	\$3,895	\$3,499
M2386	The Edge - Additional Battery 24V 20Ah	\$640	\$599



Self Propelled Electric Scissor Lift Trolley (with cage)

- Centre drive wheel it makes it extremely easy to maneuver loads in narrow aisles or tight spaces
- Side cage can be easily removed if not required
- Charging unit supplied
- 4 x 150mm swivel castors with brakes
- 2 x pneumatic centre drive wheels
- Batteries: 2x12V 33Ah
- Controller: 70A
- Overall Size: 1240x600x1100mm
- Min Plate Height: 460mm
- Motor (Driving): 400W
- Motor (Lifting): 400W
- Lifting Time: 17 seconds
- Middle Wheels: 275mm
- Table Size: 1000x600mm
- Lifting Range: 460-900mm
- Cage Height: 600mm
- Unit Weight: 180kg



Code	WAS	NOW
M2080	\$6,382	\$5,743

Scissor Lift Trolley (300kg capacity)

- Safety overload bypass valve
- Positive braking system on rear wheels
- Foot operated hydraulic operation
- Lever release control
- Powdercoated finish
- Stepless rate of lowering regardless of load weight
- Platform Size: 850x500mm
- Minimum Height: 340mm
- Maximum Height: 900mm
- Load Capacity: 300kg
- Unit Weight: 77kg



Code	WAS	NOW
M2001	\$759	\$683

Rough Terrain Scissor Lift Trolley

- Rough terrain scissor lift trolley is ideal for outdoor applications
- Foot Pedal Cycles to Max Height: 25
- Durable powder coated finish
- Rubber castors: 2 x fixed & 2 x swivel with brakes
- Load Capacity: 200kg
- Max. Lift Height: 1000mm
- Min. Height of Table: 330mm
- Table Size: 1000x500mm
- Overall Length: 1120mm
- Castors: 200mm
- Lifting Range: 340-1010mm
- Unit Weight: 71kg



Code	WAS	NOW
M2015	\$1,085	\$971

Extra Large Scissor Lift Trolleys

- Foot operated hydraulic operation with lever release control & positive braking system on rear wheels
- Safety overload bypass valve
- Durable powdercoated finish
- Stepless rate of lowering
- **M2020:**
125mm Polyurethane castors
- 2 x fixed & 2 x swivel with brakes
Unit Weight: 154kg
Lifting Range: 290-915mm
Table size: 1600x810mm
- **M2021:**
180mm Nylon castors:
- 2 x fixed & 2 x swivel with brakes
Unit Weight: 198kg
Lifting Range: 360-1360mm
Table Size: 2035x750mm



M2020



M2021

Code	Details	WAS	NOW
M2020	Extra Large Scissor Lift Trolley (500kg Capacity)	\$1,541	\$1,382
M2021	Extra Large Scissor Lift Trolley (1000kg Capacity)	\$2,365	\$2,127



2.5 Tonne Forklift Tine Hook

- Converts forklift into a mobile crane in seconds
- Adjustable mounting position along the length of the fork
- Secured to forks by thumb screw
- Swivel hook includes safety latch
- Fork Pocket Size (LxW): 150x60mm
- Capacity: 2500kg
- Unit Weight: 25kg

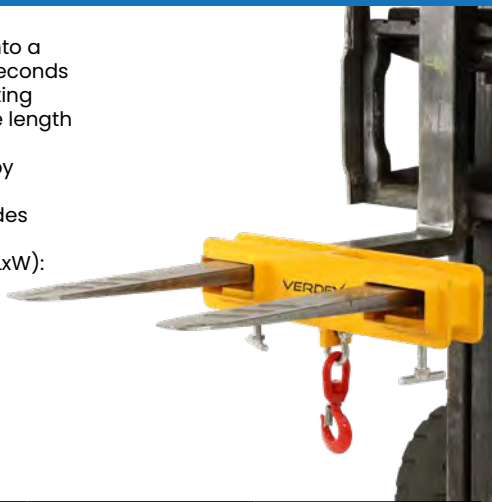

Code	WAS	NOW
M2440	\$536	\$482

2 Tonne Hook & Tow Jib

- Safe Working Load: 2000kg
- Load Centre: 1160mm
- HGC: 655mm
- Fork Pocket Size: 140x65mm
- Fork Pocket Centres: 250mm
- Fork Pocket Length: 1220mm
- Finish: Zinc plated
- Overall dimensions: 1410x420x140mm (LxWxH)
- Maximum weight on towball must not exceed 500kg
- Hook jib has 2 lifting positions
- Unit Weight: 45kg



Code	WAS	NOW
M2430	\$650	\$585

4.5 Tonne Telescopic Long Jib

- A general purpose jib which is great for reaching across pits & areas where the forklifts can't reach as it has a 3.5 metre reach when fully extended
- Finish: Zinc plated
- 6 Jib Positions
- Safe Working Load: 4500kg (SWL load chart is shown on jib)
- Load Centre: 870mm
- HGC: 836mm
- Jib Length (when closed): 2000mm
- Jib Length (when extended): 3500mm
- Fork Pocket Size: 185x65mm
- Fork Pocket Centres: 290mm
- Unit Weight: 140kg

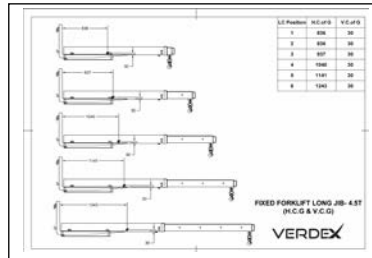

SWL load chart is shown on jib



*Jib fully extended

Code	WAS	NOW
M2421	\$1,678	\$1,510

4.5 Tonne Telescopic Short Jib

- General purpose jib which is great for confined spaces & has a 1.9 metre reach when fully extended
- Finish: Zinc plated
- 4 jib positions
- Safe Working Load: 4500kg
- Load Centre: 670mm
- HGC: 542mm
- Jib Length (when closed): 1250mm
- Jib Length (when extended): 1900mm
- Fork Pocket Size: 185x65mm
- Fork Pocket Centres: 290mm
- Unit Weight: 95kg

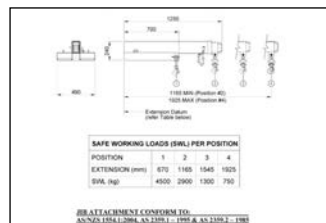

SWL load chart is shown on jib

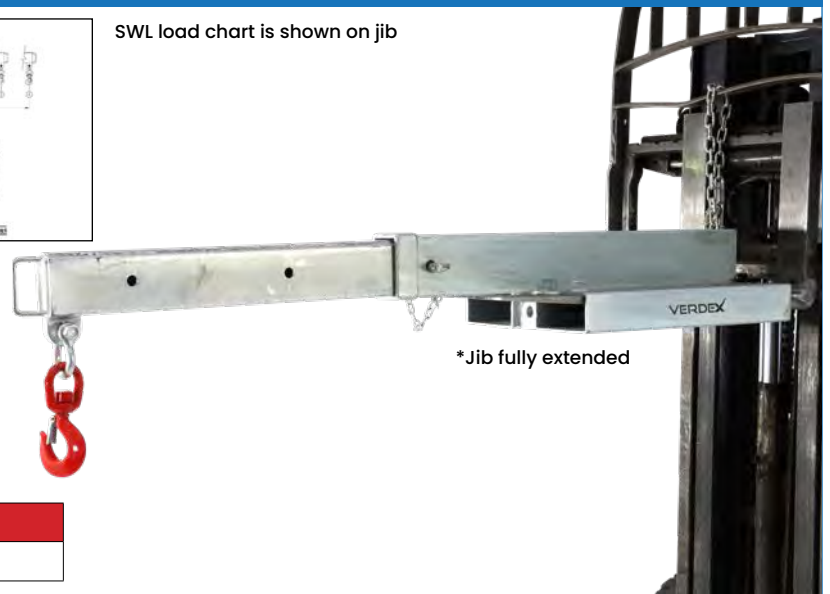

*Jib fully extended

Code	WAS	NOW
M2420	\$1,420	\$1,278



Gas Cylinder Cage

- Designed to safely store & transport gas cylinders by forklift or overhead crane
- 4 crane lifting lugs at top & 2 forklift pockets underneath for easy transport
- Suitable for many different sized cylinders
- Load binder allows cylinders to be securely fastened in position
- Folding ramp for easy access, reducing unsafe lifting of cylinders by personnel
- Stacks 2 x high when fully loaded
- Crane Working Load Limit: 500kg
- Forklift Working Load Limit: 1000kg
- Overall Dimensions: (WxDxH) 1200x850x1065mm
- Internal Dimensions: (WxD) 1050x700mm
- Fork Pocket Size: 192x92mm
- Fork Pocket Centres: 600mm
- Unit Weight: 120kg
- Zinc finish



Code	WAS	NOW
M7602	\$1,340	\$1,206

Automatic Pallet Hook 2000kg

- The automatic pallet hook is self-levelling for ease of operation. An internal spring mechanism ensures the lifting eye is in the correct position to keep the tines horizontal, eliminating the need to reposition the lifting ring. Enclosed frame members protect the operator from moving parts.
- Designed & certified in accordance with the relevant Australian Standards
- Self levels automatically
- Finish: Zinc plated
- Safe Working Load (SWL): 250-2000kg
- Load Centre: 600mm
- Adjustable Tine Size: 100x45x1055mm
- Clearance: 1355mm
- Unit Weight: 196kg



Code	WAS	NOW
M2462	\$2,235	\$2,008

Extension Slippers (Galvanised)

- Designed with a slim profile to extend the flexibility & versatility of forklifts
- Galvanised Finish
- Slippers conform to AS2359.15
- Load Centre: 600mm
- Internal Tine Size: 138x55mm
- External Tine Size: 150x67mm
- HCG: 1154mm
- Length: 2400mm
- Unit Weight: 88kg per pair
- Safe Working Load: 4500kg



Code	WAS	NOW
M2406	\$675	\$597

Bulk Bag Filling Frame

- 4 safety swivel hooks hold bulk bag in position whilst filling
- Adjustable bag restraining chains position bulk bag at correct height
- 3 adjustable height settings
- Fork pockets fitted for easy transport
- Optional clamshell gate & spill guard available online
- Upper hopper assembly:
Enamel paint finish
- Support frame: Zinc finish
- Working Load Limit (WLL): 1000kg
- Overall Dimensions: 1800x1150mm
- Hopper Opening: 554x400mm
- Fork Pocket Size: 140x65mm
- Fork Pocket Centres: 850mm
- Unit Weight: 270kg



Code	WAS	NOW
M6220	\$2,440	\$2,196

Bulk Bag Lifter

- Designed for lifting bulk bags by overhead crane
- Enamel paint finish
- Designed with 4 lifting loops for easy positioning of bulk bag
- Suits 80cm standard bulk bags
- Safe Working Load: 2000kg
- Hook Centre 'A': 800mm
- Hook Centre 'B': 1170mm
- Unit Weight: 45kg



Code	WAS	NOW
M2537	\$1,210	\$1,089

Fork Spreader with Load Guard - 3000kg

- Safely lift extra wide or flexible loads without the risk of damage to products such as plasterboard, roof sheeting, timber, plastic tubing etc.
- The fork spreader evenly distributes the load over the length of the attachment with a load back guard to help secure high loads. The slip-on attachment is secured to the lift truck by a safety chain.
- Capacity: 3000kg at 600mm Load Centre
- Spreader Width: 3000mm
- Spreader Depth: 1200mm
- Load Guard Height: 560mm
- Pocket Size: 160x60mm
- Pocket Centres: 872mm
- Tine Size (LxWxH): 1050x100x45mm
- Unit Weight: 255kg



Code	WAS	NOW
M2476	\$2,480	\$2,232



Side Shift Drum Depalletiser

- This unique design side shift drum depalletiser can pickup drums from any position on the pallet, skid or bund – straddles beside & over the pallet
- Suitable for both steel & plastic drums
- The operator requires only 12kg of force on the handle to lift a 300kg drum
- Load Capacity: 350kgs
- Overall Size (LxWxH): 920x1550x1520mm
- Ground / Pallet Clearance: 350mm
- Max Lift Height: 575mm
- Unit Weight: 168kg



Watch a video of this in operation on our website here: www.mhaproducts.com.au/M5160



Code	WAS	NOW
M5160	\$4,995	\$3,449

Deluxe Drum Cradle

- Heavy duty drum cradle with retractable handles for use on 210 litre steel drums
- Great for moving drums around the site & to lay drums into the side position
- Durable zinc plated finish
- Single person operation
- Load Capacity: 300kgs
- Wheel Type: Nylon
- Overall Width: 370mm
- Overall Length: 1000mm
- Height: 450mm (horizontal)
- Unit Weight: 14.5kg



Code	WAS	NOW
M5000	\$325	\$292

Galvanised Parrot Beak Drum Lifter

- Suitable for both steel & plastic 210 litre drums
- Simple auto clamp operation – no need to leave the drivers seat
- Allows the operator to remove and place drums on pallets or bunds without having to leave the forklift seat
- Load Capacity: 1000kg
- Load Centre: 1194mm
- HCG: 575mm
- Finish: Zinc plated
- Fork Pocket Centres: 250mm
- Fork Pocket Size: 185x60mm
- Unit Weight: 68kg



Code	WAS	NOW
M5085	\$875	\$787

Low Profile Drum Trolley

- This drum trolley has a built in handle which is used for tilting the drum back to push the trolley under (as pictured)
- Handle has built in bung remover & seal remover
- Raises drum 25mm
- Capacity: 500kg
- Overall Size: 950x570x750mm (HxDxW)
- Front Wheel Size: 150x50mm
- Rear Wheel Size: 75x32mm
- Unit Weight: 17kg



Code	WAS	NOW
M5045	\$299	\$269

Galvanised 4 Drum Spill Bin

- Suits 4 x 205 litre drums
- Close spacing support bars
- Fitted with a drain plug
- Elevated base allows transport by forklift or pallet trolley
- Steel fabricated, non-flammable unit
- Load Capacity: 2000kg
- Spill Capacity: 245L
- Overall Dimensions: 1210x1210x265mm
- Fork Pocket Centres: 450mm / 910mm
- Galvanised finish
- Fork Pocket Size: 245x80mm/180x80mm
- Unit Weight: 70kg



Code	WAS	NOW
M7582	\$730	\$667



Single & Double IBC Bunded Pallets

- Heavy duty bunded pallets made from UV stabilised polyethylene
- Removable grate & nestable when not in use for easy storage
- Easy forklift & pallet truck entry
- Corrosion Resistant
- Complies with safety standard & EPA requirements
- Complies with AS4326-2008, AS2714-2008, AS/NZS-4452-1997, AS3780-2008
- SWL: 3000kg (static)
- M7677 Overall Size (LxWxH): 1350x1350x900mm
- M7678 Overall Size (LxWxH): 2200x1300x500mm
- M7677 Unit Weight: 71kg
- M7678 Unit Weight: 96kg



M7677



M7678

Code	Details	WAS	NOW
M7677	Single IBC Bunded Pallet (1300L Capacity)	\$2,100	\$1,845
M7678	Double IBC Bunded Pallet (1100L Capacity)	\$2,250	\$1,980

4 Drum Bunded Spill Pallet

- Heavy duty bunded pallets made from UV stabilised polyethylene
- Removable grate & nestable for easy storage
- Easy 4 way forklift & pallet truck entry
- Corrosion resistant
- Dimensions: 1300x1300x300mm
- Complies with safety standard & EPA requirements
- Spill capacity: 250L
- Hold up to 4 x 205L Drums
- SWL: 2.80T Static & 1.5T Dynamic
- Unit Weight: 32kg



Code	WAS	NOW
M7673	\$538	\$469

Concrete Collection Tray

- Designed to limit environmental damage wherever a concrete pump is being used on site.
- Fitted with crane lifting & up-ending lugs
- 4-way fork pockets allows access from all sides
- Optional disposable plastic liner (CCNDPL)
- Enamel paint finish
- Working Load Limit: 1000kg
- Capacity: 0.5 cu.m
- Overall Size: 1860x1560x360mm
- Fork Pocket Size: 170x85mm
- Fork Pocket Centres: 880mm
- Unit Weight: 150kg



Code	WAS	NOW
M6210	\$1,450	\$1,276

Concrete Block Mould

- Lightweight & stackable design with simple construction
- Provision for cast in ferrule (suits 12mm reinforcing bar)
- Supplied with a single M20 eyebolt & ferrule
- Finished Block Dimensions: 1200x600x600mm
- Overall Dimensions: 1356x756x600mm
- Enamel paint finish
- Finished Block Weight: 950kg
- Capacity: 0.432cu.m
- Unit Weight: 178kg



M6200



Watch a video of this in operation on our website here: www.mhaproducts.com.au/M6200



Code	Details	WAS	NOW
M6200	Concrete Block Mould	\$1,880	\$1,692
M6201	Half Mould Insert to suit M6200	\$450	\$405
M6205	Ferrule Kit (Includes Ferrule, 1m Reo Bar & M20 Eyebolt)	\$35	\$31.50
M6206	M20 Eyebolt	\$10	\$9

M6205 & M6206



M6201



Half mould insert available for smaller blocks to be used in retaining wall applications



Mesh Storage Cage

- This storage cage is a versatile multi-use cage with over 1m² of usable space designed to suit your warehousing & storage requirements
- Working Load Limit: 500kg
- Overall Dimensions (WxDxH): 1160x580x1985mm
- Spacing between shelves: 420mm
- Reversible opening gate
- Longlife durable zinc finish
- Optional castor kit: 100mm castors (2 x fixed & 2 x swivel)
- Unit Weight: 145kg



Code	WAS	NOW
M7605	\$1,940	\$1,746

Lockable Gas Storage Cage

- Secure gas cylinder cage, suitable for workshops, building sites & mines
- Finish: Zinc plated
- Safe Working Load: 750kg
- Load Centre: 515mm
- HCG: 600mm
- Overall Size of M7600 (WxDxH): 1060x1060x1900mm
- Internal Size of M7600 (WxDxH): 930x930x1850mm
- Overall Size of M7601 (WxDxH): 500x1015x40mm
- Fork Pocket Size: 165x65mm
- Fork Pocket Centre: 665mm
- Unit Weight of M7600: 180kg



Code	WAS	NOW
M7600	\$1,679	\$1,511

Forklift Safety Cage / Work Platform

- Internal handrail with safety loops to hook safety harness
- Supplied with 2 locking pins & bars which lock the cage onto the forklift tines when in use
- Toe boards all sides with skid resistant floor plate
- Conforms to AS 2359-1
- Zinc plated finish
- Designed to carry 2 persons (250kg max)
- Mesh safety screen
- Inward opening, self closing door
- Full length fork sleeves
- Load Capacity: 250kg
- Load Centre: 600mm
- HCG: 550mm
- Internal Floor Dimensions: 1000x1100mm
- Overall Height: 2000mm
- Height to Railing: 1000mm
- Fork Pocket Size: 160x60mm
- Fork Pocket Centres: 640mm
- Unit Weight: 124kg



Code	WAS	NOW
M4000	\$1,080	\$980

Safety Cabinet For Corrosive Goods (100L Capacity)

- Heavy duty 1.2mm double skin wall construction, with 40mm air gap to provide thermal insulation
- Sequential Self closing door mechanism, with three-point lock
- 150mm depth, liquid tight sump
- Made to AS 3780:2008
- Adjustable galvanised shelves with PVC spill trays
- Internal Size (HxWxD): 560x835x530mm
- External Size (HxWxD): 810x935x680mm
- Storage Capacity: 100L
- 2.5L Drums Capacity: 15
- Number of Shelves: 1
- Unit Weight: 100kg



Code	WAS	NOW
M7692	\$1,745	\$1,570



Site Tool Cabinet – Single Door

- Heavy duty construction
- Fitted with crane lugs & fork pockets
- 2 adjustable shelves
- Dual locking mechanism
- Wheels fitted (removable)
- Powder coated finish
- Working Load Limit: 1000kg
- Load Centre: 350mm
- HCG: 376mm
- Opening (WxH): 1055x1055mm
- Overall Dimensions (WxDxH): 1155x700x1450mm
- Fork Pocket Size: 166x67mm
- Fork Pocket Centres: 660mm
- Unit Weight: 180kg



Code	WAS	NOW
M7570	\$1,970	\$1,695

Fork Gas Storage Cage – 4 Cylinders

- Powdercoated green
- Cylinder chain restraint
- All cages have padlockable doors for increased safety
- Complies with Australian Standards
- LPG Cylinder Capacity: 4
- Door Opening Size: 650x810mm
- Internal Size (LxWxH): 690x680x845mm
- External Size (LxWxH): 730x730x990mm
- Unit Weight: 43kg



Code	WAS	NOW
M7621	\$995	\$894

Flammable Liquid Cabinet – 30L

- Zinc coated steel sheeting
- Stainless steel continuous pin hinging
- Powdercoated finish
- Made to AS 1940-2017
- Door Opening Size: 420x555mm
- Internal Size (LxWxH): 420x375x555mm
- External Size (LxWxH): 505x465x800mm
- Storage Capacity: 30L
- 4L Drum Capacity: 8
- 20L Drum Capacity: 1
- No. of Shelves: 1
- Unit Weight: 43kg



Code	WAS	NOW
M7650	\$1,085	\$976

Flammable Liquid Cabinet – 250L

- Zinc coated steel sheeting
- Stainless steel continuous pin hinging
- Powdercoated finish
- Made to AS 1940-2017
- Door Opening Size: 1015x1605mm
- Internal Size (LxWxH): 1015x410x1605mm
- External Size (LxWxH): 1100x500x1850mm
- Storage Capacity: 250L
- 4L Drum Capacity: 70
- 20L Drum Capacity: 9
- No. of Shelves: 3
- Unit Weight: 165kg



Code	WAS	NOW
M7610	\$2,015	\$1,848

Aerosol Cage – 12 Can Capacity

- Powdercoated green
- All cages have lockable doors & bolt down plates for added security
- Complies with relevant Australian standards
- Storage Capacity: 12 cans
- Door Opening Size: 440x320mm
- Internal Size (LxWxH): 490x205x355mm
- External Size (LxWxH): 500x250x400mm
- Unit Weight: 12kg



Code	WAS	NOW
M7660	\$510	\$443

Aerosol Cage – 216 Can Capacity

- Powdercoated green
- All cages have lockable doors & bolt down plates for added security
- Complies with relevant Australian standards
- Storage Capacity: 216 cans
- Distance between shelves: 365mm (top) 325mm (1-4 levels)
- Door Opening Size: 770x1720mm
- Internal Size (LxWxH): 847x368x1750mm
- External Size (LxWxH): 850x400x1800mm
- Unit Weight: 77kg



Code	WAS	NOW
M7664	\$1,382	\$1,245



Access Plastic Bin Rack

- These access bin rack stores & displays products for easy access & stock picking
- Bin rack is supplied as standard with blue bins as pictured
- Storage Bin Size: 430x323x210mm (LxWxD)
- M8101 includes 28 x No. 4D storage bins
- M8101 Overall Size: 2400x1800x450mm
- Extra strong powdercoated frames & beams
- Shelf Capacity: 290kg/level
- This rack can have castors fitted for easy maneuverability
- These racks can be made in other custom sizes and configurations on request



Code	Details	WAS	NOW
M8101	Access Plastic Bin Rack (includes 28 blue plastic bins)	\$988	\$889
M8101A	Access Plastic Bin Rack - Add on Bay	\$925	\$832

Heavy Duty Longspan Shelving (with steel shelves)

- This heavy duty longspan shelving system is a strong and versatile shelving system which is great for any storing small parts & archives
- Supplied standard with 3 adjustable shelves however extra shelf levels can be ordered for each set
- Comes standard with steel shelves (2 pieces per level)
- End frames are supplied assembled for quick & easy setup
- Shelf Capacity: 390kg/level
- Height: 2400mm
- Width: 1800mm
- Depth: 600mm



Code	Details	WAS	NOW
M8006	Longspan Shelving Set	\$684	\$614
M8007	Longspan Shelving Set - Add on Bay	\$586	\$527

Vented Collapsible Bin & Lid

- Made from UV Stabilised PP
- Full recyclable & Food Grade Approved
- Bin Open Dimensions: 1162x1162x780mm
- Lid Dimensions: 1172x1172x63mm
- 2 way forklift & pallet truck Entry
- Racking Capacity 500kg
- Dynamic Capacity 1000kg
- Static Capacity 4000kg
- 3:1 Fold Down ratio
- Pallet Rack Safe
- Volume 730L
- Lid Unit weight: 6.2kg
- Bin Unit Weight 46kg



M7816



Code	Details	WAS	NOW
M7811	Vented Collapsible Bin	\$495	\$455
M7816	Lid to suit Vented Collapsible Bin	\$195	\$178

Can safely stack up to 10 bins high when empty, 7 high at 300kg, 5 high at 500kg & 3 high at 700kg



Open Steel Shelving Unit

- Open Steel Shelving Unit is roll formed from durable premium pre-painted steel
- Designed for both office & warehouse applications
- Comes with 4 Shelves
- Optional shelves sold as a pair available (can fit up to 14 shelves at 118 pitch)
- Overall Size: (LxWxH):
M7085 - 890x455x2200mm
M7086 - 887x420x25mm
- Powder coat finish
- Maximum Capacity: 250kg
- Shelf Capacity: 20kg



M7085



Suited to fit our Spare Parts Trays & Stor-Pak bins on pg. 25 (sold separately)



M7086 Extra Shelf to suit Open Steel Shelving Unit (sold as a pair)

Code	Details	Unit Weight (kg)	WAS	NOW
M7085	Open Steel Shelving Unit	40	\$435	\$391
M7086	Extra Shelves to suit Steel Shelving Unit (pair)	3.25	\$42	\$38

Stationary Cabinets

- Versatile, functional & practical steel office furniture allows freedom to create & configure storage solutions to suit your individual requirements
- Supplied fully assembled
- All Cupboards are Key lockable
- Available in 1/2 Height & Full Height Sizes
- Full height cabinet comes standard with 3 shelves (extra shelves available)
- 1/2 height cabinet comes standard with 1 shelf (extra shelves available)
- Shelf Thickness: 25mm
- Extra Shelves are supplied with clips



M7070



M7071



Graphic Ripple

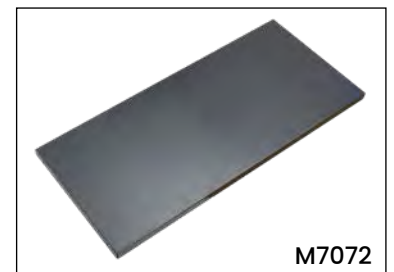

M7072

Code	Details	Dimensions (mm) (WxH)	WAS	NOW
M7070	Half Height Stationary Cabinet (Dark Grey)	1015x910x450	\$342	\$307
M7071	Full Height Stationary Cabinet (Dark Grey)	1830x910x450	\$408	\$382
M7072	Extra Shelf to suit M7070 & M7071	900x390	\$38	\$35



Stor-Pak Bins

- Ideal for small parts storage
- Sit them on shelves, benches, stack them or clip them to louvre panels
- Hospital grade material - bacterial & chemical free
- Colours: green, red, yellow, orange, blue & clear
- Dividers available for #60, #120 & #240 bins



Code	Details	Size (WxDxH)	CTN QTY	NOW
IH-060	Stor-Pak No.5	110x115x60mm	12	\$31.20/Ctn
IH-061	Stor-Pak No.10	100x170x85mm	6	\$21.30/Ctn
IH-062	Stor-Pak No.25	133x220x125mm	6	\$33.60/Ctn
IH-063	Stor-Pak No.60	200x275x165mm	6	\$64.50/Ctn
IH-064	Stor-Pak No.120	410x275x165mm	5	\$81/Ctn
IH-065	Stor-Pak No.240	410x440x210mm	4	\$114/Ctn
IH-200	Stor-Pak No.80	200x440x165mm	6	\$94.20/Ctn
IH-058	Divider (fits bins #60 & #120)	-	40	\$2.50 ea
IH-057	Divider (fits bin #240)	-	45	\$4.50 ea



Spare Parts Trays with Dividers

- Strong oil resistant parts trays with dividers that can be repositioned to suit. Ideal for Trade, Workstations, Medical Operators, Car, Home, Office or Workshops
- Parts trays are available in 6 different sizes
- Hospital grade material - bacterial & chemical free
- Will fit standard shelving
- Dividers can be removed or added
- Front grab handle with name slot
- Resists oils & dirt

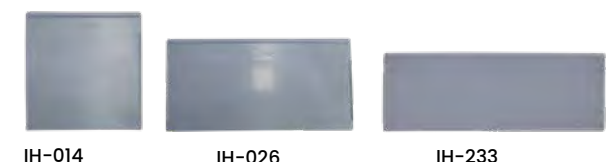

Code	Details	Size (LxWxH)	CTN QTY	NOW
IH-012	Spare Parts Tray No.12	300x100x100mm	24	\$135.60/Ctn
IH-017	Spare Parts Tray No.17	400x100x100mm	24	\$164.40/Ctn
IH-024	Spare Parts Tray No.24	300x200x100mm	12	\$104.40/Ctn
IH-025	Spare Parts Tray No.25	400x200x100mm	12	\$125.40/Ctn
IH-027	Spare Parts Tray No.27	600x100x100mm	12	\$129/Ctn
IH-028	Spare Parts Tray No.28	600x200x100mm	6	\$87.60/Ctn
IH-230	Spare Parts Tray No.30	300x300x100mm	8	\$107.40/Ctn
IH-231	Spare Parts Tray No.31	400x300x100mm	8	\$130/Ctn
IH-232	Spare Parts Tray No.32	600x300x100mm	4	\$105/Ctn
IH-014	Dividers to fit #12, #17, #27	100mm wide	12	\$6/Ctn
IH-026	Dividers to fit #24, #25, #28	200mm wide	12	\$9/Ctn
IH-233	Dividers to fit #30, #31, #32	300mm wide	12	\$17.40/Ctn



Mesh Storage Cage

- Pallet Rack Safe – unique positive locking base design for racking
- Drop down removable front gate
- Cages can be stacked:
3 x high when loaded
& 5 x high when unloaded
- Finish: Zinc plated
- Optional Gal Floor sold separately
- Optional Full Height Divider sold separately
- Load Capacity: 1000kg
- Internal Size (LxWxH): 1070x1070x840mm
- Overall Size (LxWxH): 1160x1205x1041mm
- Mesh Size: 50x50mm opening
- Unit Weight: 80kg



Watch a video of this in operation on our website here:
www.mhproducts.com.au/M7530



Code	WAS	NOW
M7530	\$625	\$558

Stackable Mesh Stillage Picking Cage

- Can be double stacked
- Drop down/removable gates
- Supplied flatpacked for easy transport
- Mesh stillage cages can be stacked:
2 x high when loaded
& 3 x high when unloaded
- Powder coated blue finish
- Base Height: 400mm
- Overall Size (WxDxH): 1165x1165x1650mm
- Load Capacity: 750kg
- Unit Weight: 96kg



Watch a video of this in operation on our website here:
www.mhproducts.com.au/M7532



Code	WAS	NOW
M7532	\$985	\$875

Stillage Mesh Cage (Foldable Sides)

- Pallet Rack Safe – these cages have built in racking locators making it an ideal storage cage & safe storage on pallet racking
- Powdercoated frames with galvanised mesh sides
- Front & side forklift access
- Solid steel floor
- Collapsed Height: 350mm
- Can be collapsed for storage
- Load Capacity: 1000kg
- Can be safely stacked:
2 x high fully loaded
& 4 x high empty
- Internal Size: 1134x931x790mm (LxWxH)
- Overall Size: 1250x1050x980mm (LxWxH)
- Unit Weight: 78kg



Code	WAS	NOW
M7640	\$790	\$708



Stackable Stillage Cage

- Fits standard Australian sized pallets including Chep & Loscam
- Cupped feet add an additional 100mm to the external size (50mm per side)
- Can be safely stacked 3 x high when in use
- Base Material Size: RHS 30x60x1.8mm
- Post Size: 60x2.5mm
- Load Capacity: 1000kg
- Clearance between ground & bottom frame is 110mm
- Clearance between stillages when stacked: 1545mm
- Post Height from top of base: 1490mm
- External Dimensions (LxWxH): 1390x1390x1655mm
- Internal Dimensions (LxWxH): 1250x1250x1490mm
- Finish: Zinc plated
- Base Height: 170mm
- Unit Weight: 54kg



Watch a video of this in operation on our website here: www.mhaproducts.com.au/M7525



Code	WAS	NOW
M7525	\$424	\$372

Stillage Pallet Cage (Half Height)

- Multi-purpose transport or storage cage
- Great for storing products both indoor & outdoor
- These cages can also be stored on pallet racking
- Double swing gate
- Cages can be stacked: 2 x high when loaded & 4 x high when empty
- Supplied with a hardwood timber pallet
- Finish: Zinc Plated
- Overall Dimensions (LxWxH): 1200x1200x655mm
- Internal Dimensions (LxWxH): 1080x1080x448mm
- Load Capacity: 1000kg



Pictured with optional lid & dividers



Code	WAS	NOW
M7509	\$520	\$468

Stillage Pallet Cage (Full Height)

- Multi-purpose transport or storage cage
- Great for storing products both indoor & outdoor
- These cages can also be stored on pallet racking
- Drop down removable front gate
- Optional Full Height Divider sold separately
- Cages can be stacked: 2 x high when loaded & 4 x high when empty
- Supplied with a hardwood timber pallet
- Finish: Zinc Plated
- These units are supplied flat packed
- Load Capacity: 1000kg
- Overall Dimensions (LxWxH): 1205x1165x1028mm
- Internal Dimensions (LxWxH): 1080x1080x825mm



Pictured with optional dividers



Code	WAS	NOW
M7510	\$540	\$486



Garbage Bins - 70L

- 4 x 50mm swivel castors & hinged lid
- Manufactured from high density polyethylene
- Resistant to decay, heat, frost, chemicals & UV Rays
- Overall Size (WxDxH): 450x440x680mm
- Castor Diameter: 50mm
- Capacity: 70L
- Unit Weight: 2.8kg



Code	Details	WAS	NOW
M6331	70L Garbage Bin - Blue	\$98	\$87
M6333	70L Garbage Bin - Green	\$98	\$87

Wheelie Bins with Foot Pedal - 240L

- Foot pedal operated lid
- Manufactured from high density polyethylene
- Resistant to decay, heat, frost, chemicals & UV rays
- Ideal for food preparation areas
- Wheel Diameter: 200mm
- Capacity: 240L
- Overall Dimensions: (WxDxH) 740x590x1070mm



Code	Details	WAS	NOW
M6345	Wheelie Bin with Foot Pedal - Blue	\$295	\$248
M6346	Wheelie Bin with Foot Pedal - Green	\$295	\$248

Self Dumping Tipping Bins - 1500kg Capacity

- Supplied with 4 crane lugs (top) & 2 upending lugs (underneath)
- Drain plug fitted as standard
- Optional wheel kits available online
- Safe Working Load: 1500kg
- HCG: 580mm
- Hot Dipped Galvanised finish
- Fork Pocket Size: 185x75mm
- Overall Dimensions: (LxWxH)
M6010: 1570x1010x1080mm
M6011: 1570x1305x1080mm
- Fork Pocket Centres:
M6010: 380mm | M6011: 680mm



Watch a video of this in operation on our website here: www.mhaproducts.com.au/M6010



Code	Details	Capacity	WAS	NOW
M6010	Self Dumping Tipping Bin	950L	\$1,850	\$1,645
M6011	Self Dumping Tipping Bin	1250L	\$2,105	\$1,895

Drop Bottom Bin (with mesh sides)

- Can be transported either by forklifts or cranes
- Emptying is carried out by pulling the draw rope handle which allows the floor to drop open from one side allowing complete emptying
- Safe Working Load: 1000kg
- Mesh sides with sheet metal base
- Fork Pocket Size: 165x50mm
- Fork Pocket Centres: 784mm
- Volume: 1500L
- Overall Dimensions: (LxWxH) 1540x950x1350mm
- Durable Zinc finish
- Unit weight: 158kg



Watch a video of this in operation on our website here: www.mhaproducts.com.au/M6041



Code	WAS	NOW
M6041	\$1,640	\$1,476



Forklift Waste Tipping Bin

- This light weight fork waste bin is great for use in warehouses & on sites for general waste & rubbish
- Fitted standard with 2 front wheels & 1 rear wheel for easy wheeling throughout workplace
- Simply pull the cord or handle which releases mechanism for tipping into larger bins or skips
- Polyurethane castors:
- 2 x fixed & 1 x swivel with brake
- Painted finish
- Load Capacity: 500kg
- Bin Capacity: 150L
- Castors: 125mm
- Fork Pocket Size: 140x55mm
- Fork Pocket Centres: 600mm
- Overall Size (LxWxH): 1160x750x805mm
- Height to top of lip: 710mm
- Unit Weight: 95kg



Code	Details	WAS	NOW
M6000	Forklift Waste Tipping Bin	\$1,250	\$1,124

Forklift Sweeper Attachments

- The fork mounted attachment is a quick & easy solution for sweeping products such as sand, top soil, grain etc.
- Equipped with ratchet straps to fasten securely on the forklift mast
- HCG: 205mm
- Fork Pocket Size: 218x44mm
- Fork Pocket Centre: 520mm
- Number of Bristle Rows: 8
- Bristle Height: 275mm
- M6035 Size: 1500x465x326mm
- M6036 Size: 1800x465x326mm
- M6035 Unit Weight: 75kg
- M6036 Unit Weight: 85kg

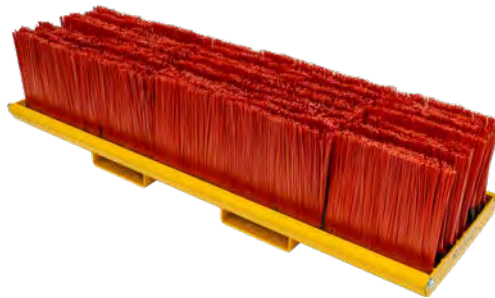

Code	Details	WAS	NOW
M6035	Forklift Sweeper - 1500mm	\$1,820	\$1,588
M6036	Forklift Sweeper - 1800mm	\$2,248	\$1,945

660L Wheelie Bin with Rotator Base

- Suitable for high volume waste & recycling
- Fitted with rotator base allowing rotation by a forklift
- 4 swivel wheels, 2 fitted with brakes for maneuverability around the workplace
- 2 large handles on each side
- Strong & sturdy design
- Smooth inner walls for ease in emptying & cleaning
- Resistant to acid, alkali, corrosion & durable to withstand impact
- Capacity: 660L
- Dimensions (LxDxH): 1370x780x1240mm
- Fork Pocket Size: 160 x 60mm
- Fork Pocket Centres: 365mm
- Unit Weight: 72kg



Code	WAS	NOW
M6365	\$850	\$789



Steel Roller Conveyor Kit

- Can be joined together to make one continuous conveyor line
- Powdercoated blue finish
- Supplied with 40 x galvanised Steel Rollers
- Supplied with 3 x stands
- Overall Size: (LxWxH) 3000x600x1105mm
- 20 Rollers Pitch: 150mm
- 40 Rollers Pitch: 75mm
- Roller Size: 527x48mm
- Capacity: 200kg/M
- Adjustable Height: 805-1105mm
- Unit Weight: 98kg
- Optional Castor Kit available online



Code	Details	WAS	NOW
M3340	Steel Roller Conveyor	\$1,585	\$1,426
M3145	Conveyor Stopper	\$55	\$48

Conveyor Gate with Steel Rollers

- Ideal to be used to create safe walk-through in a conveyor run
- Supplied With 2 Stands
- Powdercoated Blue
- Overall Size: 2025x660x1105mm
- Folding Section: 1050mm @ UP 90°
- No. of Rollers: 27PCS at 75mm Pitch
- Adjustable Height: 805-1105mm
- Unit Weight: 88kg



Code	WAS	NOW
M3144	\$1,988	\$1,789

Flexible Expanding Skate Conveyors

- Self tracking flexible expanding conveyor which expands from 1100mm to 4000mm & can be joined to make 1 continuous conveyor system
- Easy & quick setup with adjustable height legs & 125mm brake castors on every leg
- Reduces manual handling
- Bolted steel construction with skate wheels
- Capacity: 100kg per metre
- Length Retracted: 1100mm
- Length Expanded: 4000mm
- Height Range: 690 - 1000mm

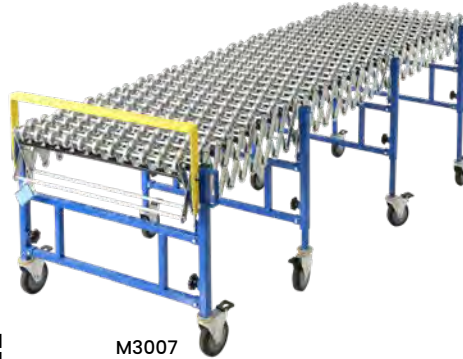

Watch a video of this in operation on our website here: www.mhaproducts.com.au/M3006



M3007

2 x M3006

Code	Details	WAS	NOW
M3006	Skate Wheel Expanding Conveyor - 610mm wide	\$2,090	\$1,895
M3007	Skate Wheel Expanding Conveyor- 760mm wide	\$2,365	\$2,194

Electric Expanding Roller Conveyors

- These conveyors are flexible, expanding from 1500mm to 4000mm & can be joined to make 1 continuous powered conveyor system
- Great for loading/unloading containers
- Easy & quick setup with adjustable height legs & 125mm brake castors on every leg
- Quiet operation 240V AC motor with forward & reverse action & adjustable roller speed
- Capacity: 140kg per metre
- Length Retracted: 1500mm
- Length Expanded: 4000mm
- Height Range: 690 - 1000mm



Code	Details	WAS	NOW
M3031	Powered Conveyor - 610mm wide	\$7,440	\$6,289
M3032	Powered Conveyor - 760mm wide	\$7,685	\$6,603



6 Tonne Capacity Container Ramp

- Great general purpose ramp for unloading containers using pallet trucks or forklifts
- This is a one piece unit with forklift slots at the front for easy transport
- Capacity: 6000kgs
- Unit Weight: 180kgs
- Finish: Painted yellow
- Fork Centres: 800mm
- Width: 2200mm
- Height: 160mm
- Length: 1200mm
- Supplied with 2 safety chains



Code	WAS	NOW
M4010	\$995	\$895

4 step Industrial Platform Ladder

- Large anti-skid work platform with raised edges - keeps feet in side the platform for greater safety & comfort
- One piece, smooth operation - simply folds out & locks
- Platform Height: 1200mm
- Platform size: 600x600mm
- Rated to 150kgs
- Complies to AS/NZS 1892:1998
- Unit Weight: 15kg



Code	WAS	NOW
M4211	\$385	\$346

Ergo Tred Anti-Fatigue Matting

- Domed surface is ergonomically designed to improve circulation in feet & legs
- Hard wearing-long mat life even in demanding conditions
- Yellow border option for hazards warning
- HACCP Certified for use in dry areas
- M7730 Size: 600x900mm
- M7733 Size: 900x1200mm



Code	Details	WAS	NOW
M7730	Anti-Fatigue Matting-Black	\$80.20	\$72
M7733	Anti-Fatigue Matting-Black & Yellow	\$165	\$151

General Purpose Plastic Step Stool

- Ideal for offices, libraries & archive areas
- Strong plastic construction with non-slip steps
- Anti-skid rubber feet
- Load Capacity: 175kg
- Overall Size: 510x510x265mm
- Platform Size: 390x390mm
- Height: 370mm
- Unit Weight: 3.3kg



Code	WAS	NOW
M4101	\$132	\$115

R1 Vehicle Max First Aid Kit

- Loaded with ARTG
- Medium-sized case with internal compartments ready for that unexpected roadside emergency
- Complies with WHS Regulations for Work Vehicles
- Dimensions: (WxHxD) 290x190x100mm



View the full list of contents on our website here:
www.mhaproducts.com.au/M9530



Code	WAS	NOW
M9530	\$96	\$89

R2 Response Plus First Aid Kit

- Complies with WHS Regulations for Workplaces, high risk 1-25 persons
- Ideal general purpose First Aid Kit for any application
- Includes Eye 'n' Wound, Burn & Outdoor modules for catering to specific injury risks in these areas
- Available in 3 case options to suit almost any application in the workplace
- Dimensions (WxHxD): 285x420x130mm



View the full list of contents on our website here:
www.mhaproducts.com.au/M9531



Code	WAS	NOW
M9531	\$395	\$355



Floor Brush with Squeegee

- This set is extremely versatile, not only allowing you to sweep your workshop for debris & dust but to also scrub it for liquid spills etc.
- 600mm Floor brush with Squeegee
- Durable 25mm Powder coated Steel Handle
- 60mm long Synthetic Bristle
- Overall Size: 590x100x1420mm
- Unit Weight: 1.3kg

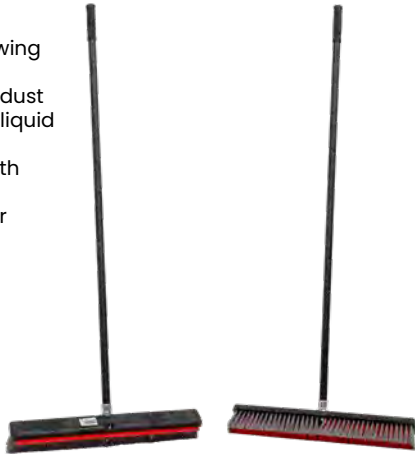

Code	WAS	NOW
M6401	\$39	\$34

Large Dustpan & Broom Set

- Handles are made from durable powder coated steel
- Broom head is constructed from durable polypropylene plastic
- Broom Handle: 20mm
- Dustpan Handle: 25mm
- 140mm long Synthetic Bristles
- Overall Size of Dustpan & Broom: 340x280x1350mm
- Opening Size: 300x100mm
- Broom Size: 340x50x1215mm
- Unit Weight: 1.8kg



Code	WAS	NOW
M6405	\$56	\$49

Floor Pallet Scales

- Great for weighing pallets or large & heavy items
- Mild Steel Construction
- Platform Size: 1200x1200mm
- Capacity: 2000kg
- Adjustable levelling feet for uneven ground
- Low Profile 70mm height from ground level
- Weighs in 500g increments
- Power Supply: 240V
- Unit Weight: 75kg



Code	WAS	NOW
M7700	\$2,352	\$2,116

Wet & Dry Vacuum Cleaner 70L

- Portable on wheel base with push handle
- Complete with all accessories
- Suitable for large workshops & factories
- Fitted with standard 10Amp 240V plug
- 2000W motor
- Airflow L/second: 106
- Hose Length: 2500mm
- Cable Length: 7200mm
- Height: 980mm
- Unit Weight: 24kg



Code	WAS	NOW
M7000	\$495	\$445

Semi-Auto Strapping Machine

- This machine is compact & light-weight, enabling easy transportation & only requires a small space for installation
- Adjustment for use of any strap in a width up to 15.5 mm can be made by slackening off only four screws
- Electric adjustment for strap length & tension
- PP Strapping Width: 5 - 15.5mm
- PP Strapping Thickness: 0.6-1.0mm
- Max Strapping Tension: 5-40kg
- Strapping Speed: 2.5 Seconds/Strap
- Max Loading Weight: 180kg
- Table Height: 750mm
- Overall Size (LxWxH): 785x545x750mm
- Unit Weight: 60kg



Watch a video of this in operation on our website here: www.mhaproducts.com.au/M7760



Code	WAS	NOW
M7760	\$1,485	\$1,295



Battery Electric Wheelie Bin Tipper

- The Multi-Tip bin-tipper is everything a bin tipper should be - safe, economic, easy to use, versatile & efficient
- Perfect for light industrial use to empty bins at schools, factories, recycling centres & more.
- These tippers are battery powered which have a sealed battery & an industrial-quality 'float' charger built in
- Option available in single or 3-phase power
- Custom cradles available to suit other bins & drums
- 150kg safe lifting capacity
- Fast 20 seconds to empty a bin
- Tipping Height: 1200 - 1600mm
- Battery-powered with a sealed battery & an industrial-quality 'float' charger built in
- Inbuilt 240V charger with LED charge indicator
- Suits popular bin sizes 80L, 120L, 140L & 240L, with no adjustment
- 125mm castors, 2 with brakes
- Rugged powder coated frame
- Zinc Plated Cradle
- Indoor or outdoor use
- Lift Height: 1600mm
- Overall Height: 2660mm
- Mast Height: 2380mm
- Width/Depth: 1235x900mm



Lockout key & two-hand controls for safety



Watch a video of this in operation on our website here: www.mhaproducts.com.au/M6080



Code	WAS	NOW
M6080	\$9,850	\$8,760

Fully-Auto Stretch Wrapping Machine

- Electronic screen with 'Soft Touch' control
- Variable film carriage and turntable speeds
- Photocell eye for automatic height detection
- Automatic and Manual wrapping programs
- Soft-start and stop turntable drive
- Ramp is supplied as an optional extra
- Ramp can be positioned anywhere around the turntable
- Ramp is great for pallet truck access
- Ramp Finish: Powercoated Blue
- Ramp Overall Size (WxLxH): 1000x1500x80mm
- Ramp Weight: 56kg
- 250% Pre-Stretch film carriage
- Heavy-duty industrial chain driven turntable
- Forklift relocation slots for easy machine transportation
- Eliminate the need for labour intensive, inefficient manual hand wrapping
- Rugged steel construction for long-term reliability
- Standard 12 month warranty
- Max height of wrapping: 2100mm
- Load capacity: 1500kg
- Fork Pocket Size: 154x54mm
- Fork Pocket Centres: 570mm
- Max pallet size: 1200x1200mm
- Turntable diameter: 1500mm
- Overall Machine Size: 2455x730x2200mm
- Turntable Height: 80mm
- Turntable speed: 1-12 RPM
- Stretch film size: 500mm
- Power supply: 240v, single phase
- Machine weight: 435kg



Electronic Screen with 'soft touch' controls



Comes supplied with a toolbox with all the necessary tools for assembly of the wrapping machine

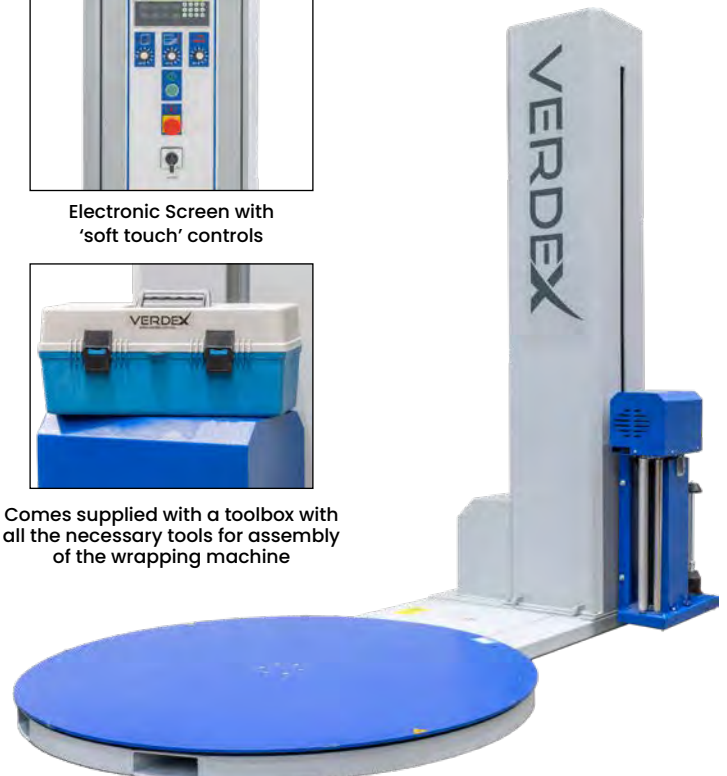

Watch a video of this in operation on our website here: www.mhaproducts.com.au/M7742



Code	WAS	NOW
M7742	\$12,300	\$9,850



7 Drawer Industrial Tooling Cabinet

- The sliding drawers are a welded strengthened single rail design coupled with high quality mechanical bearings for long lasting smooth operation
- Centre dividers are removable
- Single key lock design for safe storage
- Overall Size (WxDxH): 881x653x1200mm
- Overall Unit Capacity: 600kg
- Drawers 1-6: 150mm high
- Drawer 7: 200mm high
- 10 Dividers per Drawer
- Individual Drawer Capacity: 100kg
- Unit Weight: 121kg



All drawers come with adjustable steel dividers



Code	WAS	NOW
M7220	\$1,420	\$1,278

10 Drawer Industrial Tooling Cabinet

- Single key lock design for safe storage
- All drawers come with adjustable steel dividers
- Centre dividers are removable
- Drawers 1-9: 100mm high
- Drawer 10: 200mm high
- 10 Dividers per Drawer
- Individual Drawer Capacity: 100kg
- Overall Size (WxDxH): 881x653x1200mm
- Unit Weight: 175kg



All drawers come with adjustable steel dividers



Code	WAS	NOW
M7221	\$1,988	\$1,785

Heavy Duty Parts Cabinets

- Parts trays have a transparent front window
- Parts trays have a raised back lip to prevent accidental slip off
- Each bin comes with 1 x divider & 1 x bin label card
- External Plastic Parts Bin Size (LxWxH): 415x170x105mm
- Internal Plastic Parts Bin Size (LxWxH): 380x140x100mm
- Plastic Parts Bin Capacity: 10kg each
- Overall Size (LxWxH):
M7350 - 900x420x880mm
M7351 - 415x170x105mm
- Cabinets are supplied fully assembled with parts trays



M7353



M7350



M7351

Code	Details	Unit Weight (kg)	WAS	NOW
M7350	Heavy Duty Parts Cabinet (30 Parts Trays)	51	\$935	\$751
M7351	Heavy Duty Parts Cabinet (60 Parts Trays)	110	\$1,482	\$1,320
M7353K	Dividers to suit Parts Cabinets (Pack of 12)	-	\$30	\$27



Heavy Duty Cabinets

- These heavy duty industrial storage cabinets are made from reinforced sheet metal & are great for storing tools, parts & many other items in the workplace
- Finish: Powdercoated light grey with light blue coloured doors
- Supplied with 4 adjustable shelves
- M7201 supplied as a standard base model without drawers however can be purchased with additional shelves & units found online
- Overall Size (HxWxD): 1800x900x450mm
- Total Cabinet Load Capacity: 600kg
- 100mm Drawer Capacity: 50kg
- 200mm Drawer Capacity: 75kg
- Shelf Capacity: 100kg
- (4 slotted partitions & 10 dividers)
- **M8150** - 2 Drawer Cabinet
1 x 100mm & 1 x 200mm drawer
Unit Weight: 108kg
- **M1851** - 4 Drawer Cabinet
2 x 100mm drawers & 2 x 200mm drawers
Unit Weight: 131kg
- **M1852** - 6 Drawer Cabinet
3 x 100mm drawers & 3 x 200mm drawers
Unit Weight: 154kg



M7201



M8150



Drawers come with 5 compartments & 10 dividers (4 removable partitions)



M8151



M8152

Code	Details	WAS	NOW
M7201	Full Height Cabinet	\$785	\$703
M8150	2 Drawer Cabinet	\$1,161	\$1,045
M8151	4 Drawer Cabinet	\$1,537	\$1,383
M8152	6 Drawer Cabinet	\$1,913	\$1,720

Industrial Cabinet 1/2 Height Cabinet

- Shelf cabinet comes standard with 2 adjustable shelves however extra shelves can be purchased if required
- Made from reinforced sheet metal & are great for storing tools & many other items in the workplace
- Shelf Capacity: 150kgs
- 2 adjustable shelves as standard
- 3 point key lock system
- Optional drawer units available to suit cabinet
- Unit Weight: 49kg



2 adjustable shelves as standard

Code	WAS	NOW
M7200	\$409	\$368

Industrial Tooling Cabinet Drawer Unit

- The 1/2 height industrial cabinet can be mounted on top of the tooling cabinet
- Finish: Powdercoated light grey with light blue coloured doors
- Drawer Capacity: 75kgs
- 2 x 100mm deep drawers
- 3 x 200mm deep drawers
- 3 point key lock system
- Drawers have adjustable dividers per drawer
- Dimensions: (WxDxH) 900x450x900mm
- Unit Weight: 99kg



10 dividers supplied as standard

Code	WAS	NOW
M7210	\$1,040	\$936



Safety Swing Gate

- Restricts access to areas of potential hazard
- 2 x Authorised Personnel Only signs supplied
- Suits ball fence & SHS up to 50mm
- Fits left & right hand openings, inwards opening
- Built-in gate stop
- Self-closing stainless steel spring hinges
- Zinc Finish
- Overall Length: 910-1360mm
- Height: 440mm
- Width: 110mm
- Unit Weight: 10kg



Pedestrian Handrail Gate

- Self closing gate is designed to restrict access to areas of potential hazard
- Suits ball fence, Pedestrian Handrail System & Safety Guard rail Fencing
- Gate swings inward
- Heavy Duty adjustable tension self-closing
- Fits left & right hand openings, inwards opening
- Built-in gate softclosing hinges
- Powder Coat Finish
- Adjustable length to suit 780-1330 opening

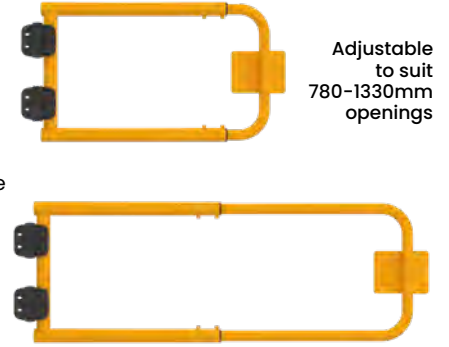

Adjustable to suit 780-1330mm openings

Code	Details	WAS	NOW
M7455	Safety Swing Gate	\$330	\$297
M7454	Post to suit M7455	\$50	\$44.50

Code	WAS	NOW
M7476K	\$395	\$354

Pedestrian Handrail System

- Easy to install modular pedestrian barrier system with 2 metre long rails to form a continuous barrier (can be cut to your desired length). The 950mm high posts simply lock together with pre-fitted couplings
- Our system uses rounded corners which allow you to have a continuous handrail along winding passageways & around corners
- No welding required, easily assembled & versatile
- Made to Australian Standards: AS 1428.1:2021 & AS 1657:2018
- Powder coated yellow Post and Rail
- Hot Dipped Galvanised Cast Iron Connectors & Base Flange
- Post Rails: 48x950mm
- Horizontal Rails: 48x2000mm
- All Post are supplied with 2 x M10 60mm Galvanised Dynabolts

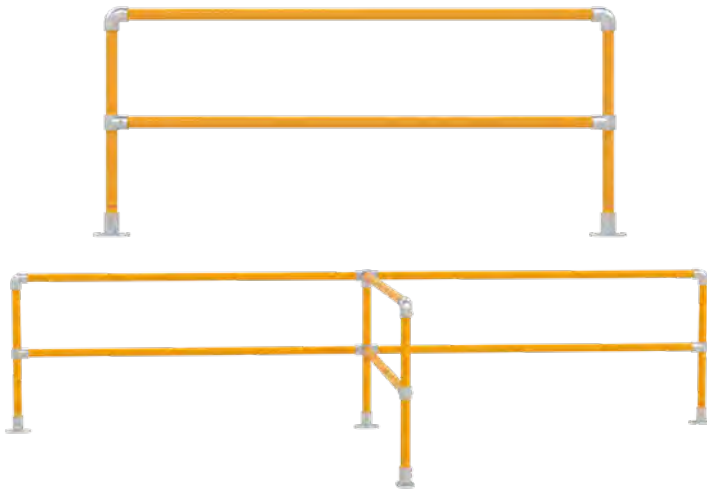

Code	Details	Dimensions (mm)	Unit Weight (kg)	WAS	NOW
M7470	2m Pedestrian Handrail (pair of 2 handrails)	48x2000	14	\$179	\$161
M7471	Pedestrian Handrail - End Post	48x880	5.5	\$170	\$153
M7472	Pedestrian Handrail - Centre Post	48x880	6	\$182	\$163
M7473	Pedestrian Handrail - Corner Post	48x880	6	\$194	\$174
M7474	4 Way Centre Cross Coupling Set & Cap (pair of 2)	-	2.7	\$40	\$36
M7475	Side Outlet Tee Set (sold as a pair of 2)	-	2	\$35	\$31



Fixed Safety Bollard

- Ideal for protecting expensive equipment & racking from possible forklift damage
- Great for protecting edges of roller doors from truck damage
- Custom sizes can be made to order to suit particular specifications
- Powdercoated yellow finish
- Bolt Hole Size: 22mm
- Base Plate Size: 203x203x10mm
- Bollard Diameter: 115mm
- Overall Size: (HxWxD) 230x1220x115mm
- Wall thickness: 3mm
- M16 Tru Bolts available to suit



Code	WAS	NOW
M7421	\$210	\$188

Large Fixed Safety Bollard

- Protects against any accidental forklift damage
- Great for protecting edges of roller doors from truck damage
- The powdercoated bollard is galvanised first then powdercoated for extra protection against rust
- Bollard Height: 1200mm
- Bollard Diameter: 165mm
- Wall Thickness: 3mm
- Base Plate Size: 280x280x10mm
- Overall Size: (DxH) 165x1200mm
- Bolt Hole Size: 17mm
- M16 Tru Bolts available to suit



Code	WAS	NOW
M7425	\$191	\$171

Safety Guard Rail Fencing

- Protect expensive equipment from forklift damage using bolt together post & panel modular system
- Heavy duty powder coat yellow steel construction
- Easily assembled & disassembled rail system
- Supplied with all necessary bolts & fixings
- We can supply & install this fencing system at your workplace - Contact us for a quotation
- Galvanised finish available on request
- Base Size of the post is 255x255x16mm
- Universal post has holes on all 4 sides & can be used for any configuration (corner, straight, T or +)

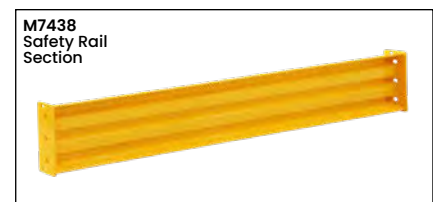
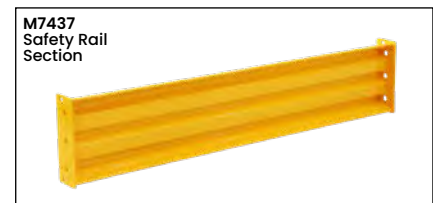
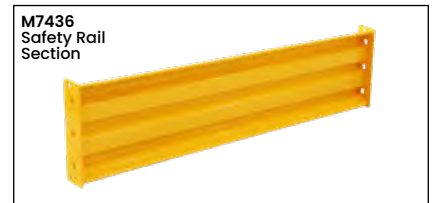

Code	Details	Dimensions (mm)	WAS	NOW
M7430	Single Height Corner Post	100x100x470 (LxWxH)	\$198	\$178
M7431	Single Height Centre / End Post	100x100x470 (LxWxH)	\$198	\$178
M7432	Double Height Universal Post	100x100x1085 (LxWxH)	\$234	\$210
M7433	Double Height Centre / End Post	100x100x1085 (LxWxH)	\$234	\$210
M7435	Safety Rail Section	370x1120 (HxL)	\$198	\$178
M7436	Safety Rail Section	370x1730 (HxL)	\$222	\$199
M7437	Safety Rail Section	370x2340 (HxL)	\$346	\$311
M7438	Safety Rail Section	370x2945 (HxL)	\$348	\$313



Modular Ergonomic Packing Workbenches

Our 2400mm Heavy Duty Modular Ergonomic Workbench comes with height adjustable legs for all your requirements or applications. It can be configured with a large range of accessories to maximise efficiency in your workspace. These benches are ideal for packing, industrial processes, workshops and multiple other applications. Configure your bench today!

- 37mm thick bench top, material is particle board with a PVC top & a high pressure, laminate underside
- 500kg capacity
- Comes standard with adjustable feet for levelling on uneven floors
- Finish: Powder coated light grey
- Bench Height: 737 to 1037mm – can adjust at 50mm increments



SCAN to view our full range of Modular Ergonomic Workbenches



Code	Accessories to suit Workbenches
M7916	Back Panel Upright 825mm
M7918	Back Panel Shelf Divider
M7919	Back Panel Tape Dispenser Holder
M7920	Back Panel A4 Document Holder
M7921	Back Panel Monitor Arm
M7922	Back Panel Label Printer Arm
M7926	Under Shelf Divider (300mm high)
M7927	Under Shelf Tool Holder
M7928	Under Shelf Slide Out Keyboard Shelf
M7929	Under Shelf Slide Out CPU/Printer Shelf
M7986	Under Shelf Kit



The Ergonomic Packaging Workbench & Accessories featured above are pictured on the 2400mm model. Visit our website to view our full range of sizes & accessories*



Custom Configurations of Ergonomic Packing Workbenches



Visit our website to create your perfect workspace today



Accessories to suit Workbenches

Code	Half Length Accessories
M7975	Back Panel Roll Holder
M7977	Back Panel Reversible/Tilting Shelf
M7979	Back Panel Bin Rail

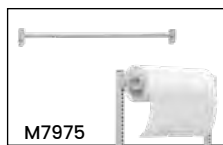

Code	Full Length Accessories
M7973	Underbench Tool Shelf Unit
M7974	Underbench Roll Holder
M7976	Back Panel Roll Holder
M7978	Back Panel Reversible/Tilting Shelf
M7980	Back Panel Bin Rail
M7982	Back Panel Light & Balancer Rail



SCAN to view our full range of Modular Ergonomic Workbenches

Visit mhaproducts.com.au/modularworkbenches to view our full range of workbenches & accessories to create your own workspace

NEW 284 PAGE CATALOGUE OUT NOW

SCAN THE QR CODE TO GET A COPY POSTED TO YOU



PM1501 - Palomat Pallet Dispenser



[View online](#)

NOW
\$25,250
SAVE \$4,250

M1720 - Scooter Stock Picker



[View online](#)

NOW
\$798
SAVE \$168

M2250 - Aluminium Hand Stacker



[View online](#)

NOW
\$1,372
SAVE \$153



DELIVERING AUSTRALIA WIDE DAILY!



BIGGEST RANGE OF SAFETY & WORKPLACE EQUIPMENT IN AUSTRALIA



Sydney (02) 8865 1800
sales@mhaproducts.com.au

Brisbane (07) 3558 9700
sales@mhaproducts.com.au

Melbourne (03) 9115 9100
sales@mhaproducts.com.au

© MHA Products 2024
ABN 38 368 064 476
Specials End 30th June 2024



EOFY
2024
\$PECIALS
ON SALE UNTIL JUNE 30TH 2024

